

DS-2SE4C425MWG-E/26(F0) TandemVu 4 MP 25× IR Network Speed Dome



Hikvision DS-2SE4C425MWG-E/26(F0) 4 MP 25 × IR Network Speed Dome adopts 1/2.8" progressive scan CMOS chip. With the 25 × optical zoom lens, the camera offers more details over expansive areas. This series of cameras can be widely used for wide ranges of high-definition, such as rivers, roads, railways, airports, squares, parks, scenic spots, and venues, etc.

- Captures a large area and great details at the same time
- High quality panoramic imaging with 6 MP resolution and details imaging with 4 MP
- Excellent low-light performance with powered-by-DarkFighter technology and ColorVu technology
- Secures an expansive area with 25× optical zoom and 16× digital zoom
- Expansive night view with up to 100 m IR distance & 30 m white light
- Supports 12V DC & PoE+
- Focuses on human and vehicle targets classification based on deep learning

▪ Specification

Camera	
Image Sensor	[Bullet channel]: 1/2.5" Progressive Scan CMOS; [PTZ channel]: 1/2.8" progressive scan CMOS
Max. Resolution	[Bullet channel] 3632 × 1632, [PTZ channel] 2560 × 1440
Min. Illumination	[Bullet channel]: 0.0005 Lux @ (F1.0, AGC ON), 0 Lux with light; [PTZ channel]: Color: 0.005 Lux @ (F1.6, AGC ON), B/W: 0.001 Lux @ (F1.6, AGC ON), 0 Lux with IR
Shutter Speed	1 s to 1/30,000 s
Slow Shutter	yes
Day & Night	ICR
Zoom	[PTZ channel] 25 × optical, 16 × digital
White Balance	auto,ATW,sodium lamp,fluorescent lamp,indoor,outdoor,MWB,Locked WB
Lens	
Focal Length	[Bullet channel]: 2.8 mm; [PTZ channel]: 4.8 to 120 mm, 25 × optical
Zoom Speed	[PTZ channel]: approx. 3.6 s
FOV	[Bullet channel]: Horizontal field of view: 180±10°, Vertical field of view: 80±5°; [PTZ channel]: Horizontal field of view: 55° to 2.4° (wide-tele), Vertical field of view: 33° to 1.4° (wide-tele), Diagonal field of view: 61.5° to 2.8° (wide-tele)
Focus	semi-auto,manual,auto
Aperture	[Bullet channel]: F1.0; [PTZ channel]: F1.6
Illuminator	
Supplement Light Type	[PTZ channel]: IR; [Bullet channel]: White Light
Smart Supplement Light	Yes
Supplement Light Range	[PTZ channel]: up to 100 m; [Bullet channel]: up to 30 m
PTZ	
Movement Range (Pan)	360°
Movement Range (Tilt)	-15° to 90° (auto flip)
Pan Speed	pan speed: configurable from 0.1° to 80°/s; preset speed: 80°/s
Tilt Speed	tilt speed: configurable from 0.1° to 80°/s, preset speed 80°/s
Proportional Zoom	yes
Presets	300
Patrol Scan	8 patrols, up to 32 presets for each patrol
Pattern Scan	4 pattern scans
Power-off Memory	yes
Park Action	preset,pattern scan,patrol scan,auto scan,tilt scan,random scan,frame scan,panorama scan
3D Positioning	yes
PTZ Status Display	yes
Preset Freezing	yes
Scheduled Task	preset,pattern scan,patrol scan,auto scan,tilt scan,random scan,frame scan,panorama scan,dome reboot,dome adjust,aux output
Exception Detection	IP address conflict, HDD full, illegal login, HDD error, network disconnected, Abnormal Restart

Video	
Region of Interest (ROI)	8 fixed regions for each stream
Main Stream	[Bullet channel] 50 Hz: 25 fps(3632 × 1632, 3680 × 1656) 60 Hz: 30 fps(3632 × 1632, 3680 × 1656) [PTZ channel] 50 Hz: 25 fps(2560 × 1440, 1920 × 1080, 1280 × 960, 1280 × 720) 60 Hz: 30 fps(2560 × 1440, 1920 × 1080, 1280 × 960, 1280 × 720)
Sub-Stream	[Bullet channel] 50 Hz: 25 fps(1200 × 536, 960 × 432) 60 Hz: 30 fps(1200 × 536, 960 × 432) [PTZ channel] 50 Hz: 25 fps(704 × 576, 640 × 480, 352 × 288) 60 Hz: 30 fps(704 × 480, 640 × 480, 352 × 240)
Third Stream	[Bullet channel] No [PTZ channel] 50 Hz: 25 fps(1920 × 1080, 1280 × 960, 1280 × 720, 704 × 576, 640 × 480, 352 × 288) 60 Hz: 30 fps(1920 × 1080, 1280 × 960, 1280 × 720, 704 × 480, 640 × 480, 352 × 240)
Video Compression	H.265,H.264,MJPEG
Video Bit Rate	32 kbps to 16384 kbps
H.264 Type	baseline profile,main profile,high profile
H.265 Type	main profile
H.264+	yes
H.265+	yes
SVC	yes
Audio	
Audio Compression	G.711,G.722.1,G.726,MP2L2,PCM,AAC-LC,MP3
Audio Bit Rate	MP2L2: 32 Kbps, 40 Kbps, 48 Kbps, 56 Kbps, 64 Kbps, 80 Kbps, 96 Kbps, 112 Kbps, 128 Kbps, 144 Kbps, 160 Kbps, 192 Kbps, AAC-LC: 16 Kbps, 32 Kbps, 64 Kbps, MP3: 8Kbps, 16Kbps, 24Kbps, 32Kbps, 40Kbps, 48Kbps, 56Kbps, 64Kbps, 80Kbps, 96Kbps, 112Kbps, 128Kbps, 160Kbps, 192Kbps, 224Kbps, 256Kbps, 320Kbps
Audio Sampling Rate	MP2L2: 16 kHz, 32 kHz, 48 kHz; AAC-LC: 16 kHz, 32 kHz, 48 kHz; PCM: 8 kHz, 16 kHz, 32 kHz, 48 kHz; MP3: 8 kHz, 16 kHz, 32 kHz, 48 kHz
Environment Noise Filtering	yes
Smart Features	
Smart Record	ANR,Dual-VCA
Network	
API	ISAPI,SDK,ISUP,ONVIF
Web Browser	IE11+,Chrome57+,Firefox52+,Safari12+,Edge79.0.309.65+
Network Storage	NAS (NFS, SMB/ CIFS), ANR
Protocols	IPv4/IPv6,HTTP,HTTPS,802.1x,Qos,FTP,SMTP,UPnP,SNMP,DNS,DDNS,NTP,RTSP,RTCP, RTP,TCP/IP,UDP,IGMP,ICMP,DHCP,PPPoE,Bonjour,WebSocket,WebSockets,SRTP
Simultaneous Live View	20
User/Host	32

Security Measures	Authenticated username and password,MAC address binding,HTTPS encryption,802.1X authenticated access,IP address filter
Client	iVMS-4200,Hik-Connect
Image	
Image Settings	sharpness, saturation, brightness, contrast
Day/Night Switch	day, night, auto, scheduled-switch
Wide Dynamic Range (WDR)	[Bullet channel] Digital WDR [PTZ channel] 120 dB WDR
SNR	≥ 52 dB
Defog	Digital defog
Image Stabilization	EIS
Image Enhancement	BLC,HLC,3D DNR
Regional Focus	Yes
Regional Exposure	Yes
Image Parameters Switch	Yes
Privacy Mask	[Bullet channel] 8 programmable polygon privacy masks, [PTZ channel] 24 programmable polygon privacy masks; mask color or mosaic configurable
Interface	
Communication Interface	RJ45, self-adaptive 10M/100M Ethernet port
On-board Storage	Built-in memory card slot, support Micro SD/Micro SDHC/Micro SDXC, up to 256 GB
Alarm Input	1 alarm input
Alarm Output	1 alarm output
Audio Input	1 audio input, 2.0 to 2.4Vp-p, 1k Ohm±10%
Audio Output	1 audio output, line level, impedance: 600 Ω
Reset	yes
Event	
Basic Event	Motion detection,video tampering alarm,exception,alarm input and output
Smart Event	audio exception detection,region entrance detection,region exiting detection,intrusion detection,Line crossing detection
Linkage	Upload to FTP/NAS/memory card,notify surveillance center,send email,trigger alarm output,trigger recording,audible warning,and PTZ actions (such as preset, patrol scan, pattern scan)
Smart Linkage	panorama linkage
Deep Learning Function	
Face Capture	Detects up to 5 faces simultaneously, Supports detecting, tracking, capturing, grading, selecting of face in motion, and outputs the best face picture
General	
General Function	mirror,watermark,password protection
Power	12VDC, PoE+
Power Consumption and Current	Max. 24 W, including max. 2.6 W for heater and max. 11 W for supplement light
Operating Conditions	-30°C to 65°C (-22°F to 149°F),humidity lower than 90%RH
Demist	Demist by heating the glass
Material	ADC12
Dimensions	∅ 166 mm × 302.6 mm (∅ 6.5" × 11.9")

Weight	Approx. 2.4 kg (13.2 lb.)
Approval	
Protection	IP66 Standard, 6000 V Lightning Protection, Surge Protection and Voltage Transient Protection

▪ **DORI**

The DORI (detect, observe, recognize, identify) distance gives the general idea of the camera ability to distinguish persons or objects within its field of view. It is calculated based on the camera sensor specification and the criteria given by EN 62676-4: 2015.

DORI	Detect	Observe	Recognize	Identify
Definition	25 px/m	63 px/m	125 px/m	250 px/m
Distance (Tele)	2200.0 m (7217.85 ft)	873.0 m (2864.17 ft)	440.0 m (1443.57 ft)	220.0 m (721.78 ft)

▪ **Available Model**

DS-2SE4C425MWG-E/26(F0)

▪ **Dimension**

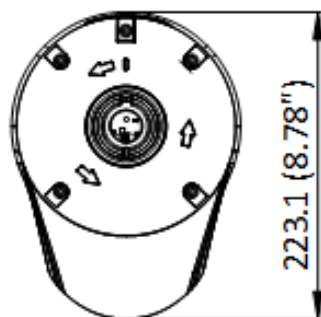
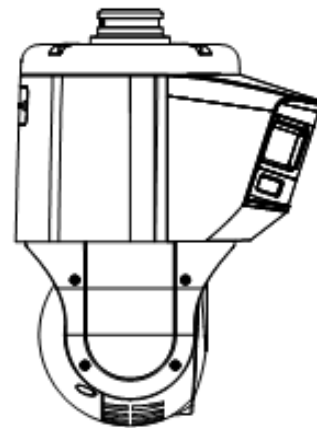
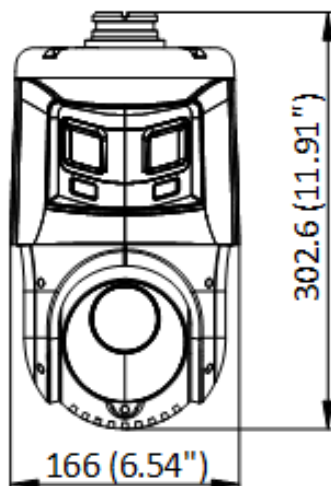







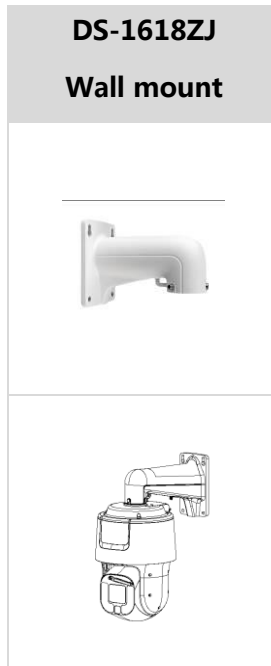



Unit: mm (inch)



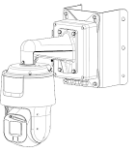
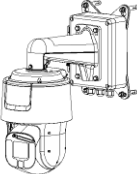
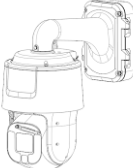
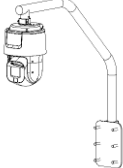





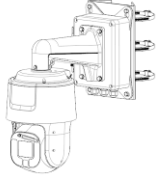
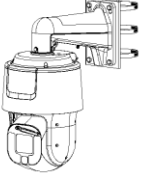

▪ **Accessory**

▪ **Included**



▪ **Optional**

DS-1604ZJ-BOX-CO RNER Wall mount	DS-1604ZJ-box Wall mount	DS-1604ZJ Wall mount	DS-1660ZJ Wall mount	DS-1661ZJ Pendant Mount
				
				
DS-1662ZJ Pendant Mount	DS-1667ZJ Pendant Mount	DS-1673ZJ Vertical pole mount	DS-1604ZJ-BOX-PO LE Vertical pole mount	DS-1684ZJ Vertical pole mount
				

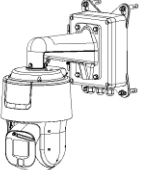
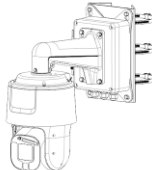
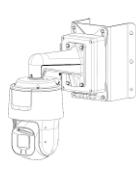
				
DS-1604ZJ-pole Vertical pole mount	DS-1663ZJ In-ceiling mount	DS-1604ZJ-corner Corner mount	DS-1619ZJ Others	DS-1602ZJ Wall mount
				
DS-1674ZJ Junction box	DS-4650ZJ-WC Vertical pole mount	DS-4660ZJ-WC Corner mount		
				
				

Headquarters

No.555 Qianmo Road, Binjiang District,
Hangzhou 310051, China
T +86-571-8807-5998
www.hikvision.com



Follow us on social media to get the latest product and solution information.

